

LÄNSPUMP

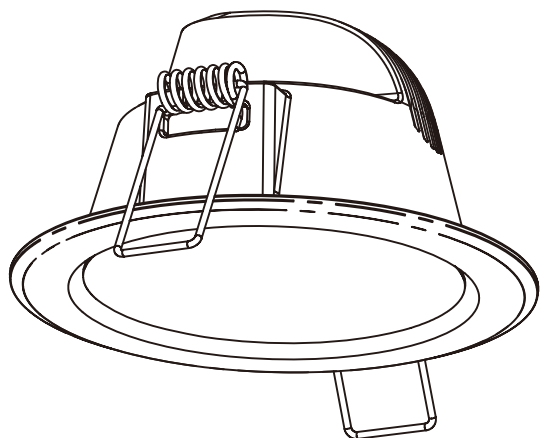

Design and Quality
IKEA of Sweden

中文

该照明装置内的光源不可替换，若光源无法继续使用，必须更换整个照明装置。

中文

灯具可直接安装于绝缘体或类似材质上，无需额外防护盒。

繁中

重要訊息！安裝前請務必關掉電源。有些國家的電力安裝工作需由有執照的專業電工執行，如有任何疑問，請聯絡專業人員。

未拆開包裝前，不可將電路連接到電源處。不可維修或更換連接線。若電線受損，請停止使用並丟棄整組裝置。

繁中

未拆開包裝前，不可將電路連接到電源處。不可維修或更換連接線。若電線受損，請停止使用並丟棄整組裝置。

繁中

不可更換燈泡；如果燈泡無法發亮，請更換整組燈具。

繁中

燈具可直接安裝在絕緣或類似材質上，不需使用防護盒。

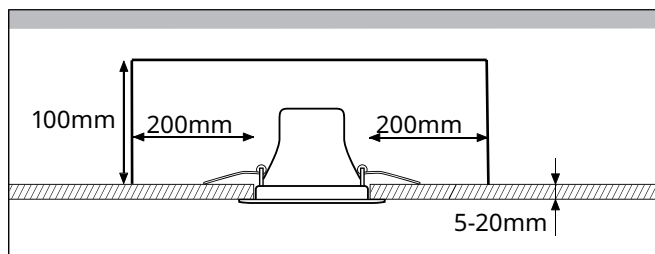

3



English IMPORTANT!

Always shut off power to the circuit before starting installation work. In some countries electrical installation work may only be carried out by a authorised electrical contractor. Contact your local electricity authority for advice.

Do not connect the product to the supply while it is in the packing. The connecting cable can not be repaired or replaced. If the cable is damaged the entire fitting must be discarded.

English

The light source of this luminaire is not replaceable; when the light source reaches its end of life the whole luminaire shall be replaced.

English

The lamp can be installed directly into the insulation or similar material, without an extra security box.

中文

重要事項！

安裝工作开始前，请务必切断电路电源。在一些国家，电气安装工作必须由授权的电力承包商进行。联系当地电力部门，征询建议。

不要在灯尚在包装中时就接通电源。连接线不可进行修理或替换。如果连接线被损坏，则必须将整个装置丢弃。

2

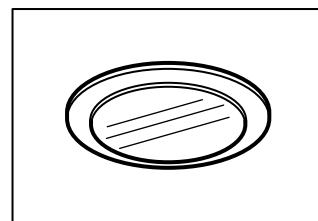
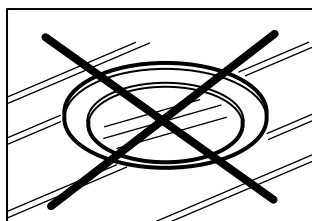

English

The lamp may only be mounted to a tight ceiling and must be placed in the correct zone.

中文

灯具只可被安装在坚固的天花板上，而且，必须置于正确的地方。

繁中

燈具只能安裝在堅固的天花板上，且須放置在正確的地方。



English

The luminaire shall not be covered with thermal insulation or similar material under any circumstance.

中文

燈具不允許被隔熱或類似材料覆蓋。

繁中

燈具不允許被隔熱或類似材料覆蓋。

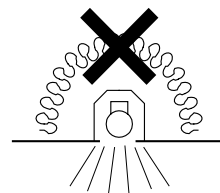

4

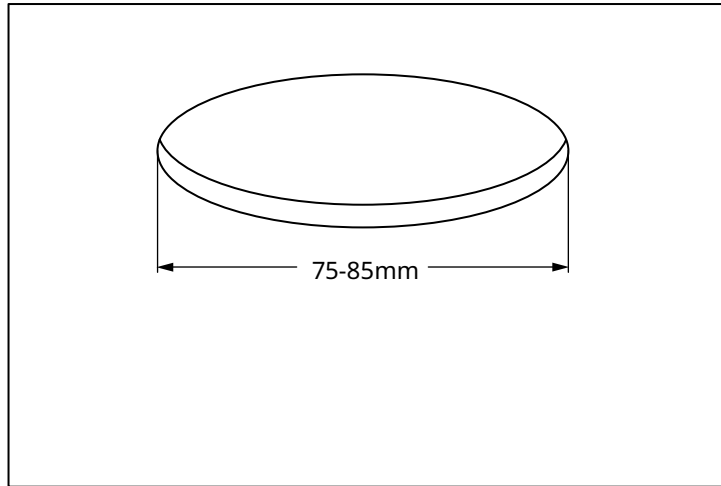
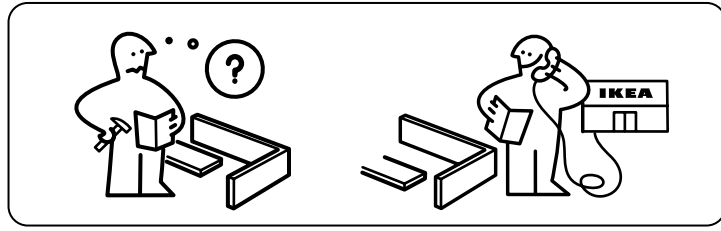
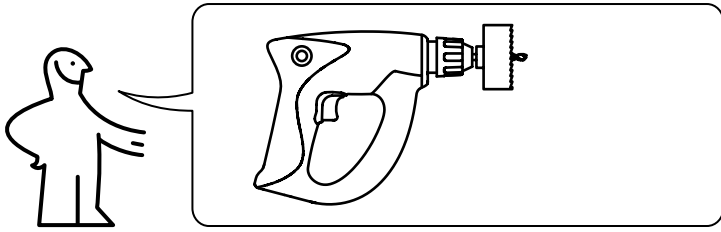

5

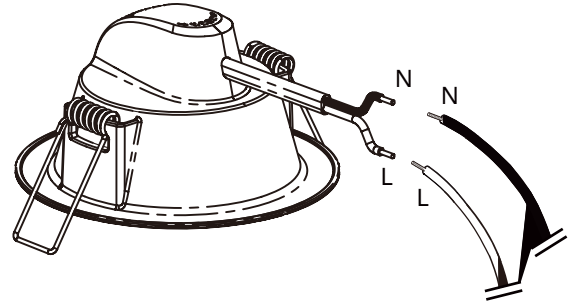

6

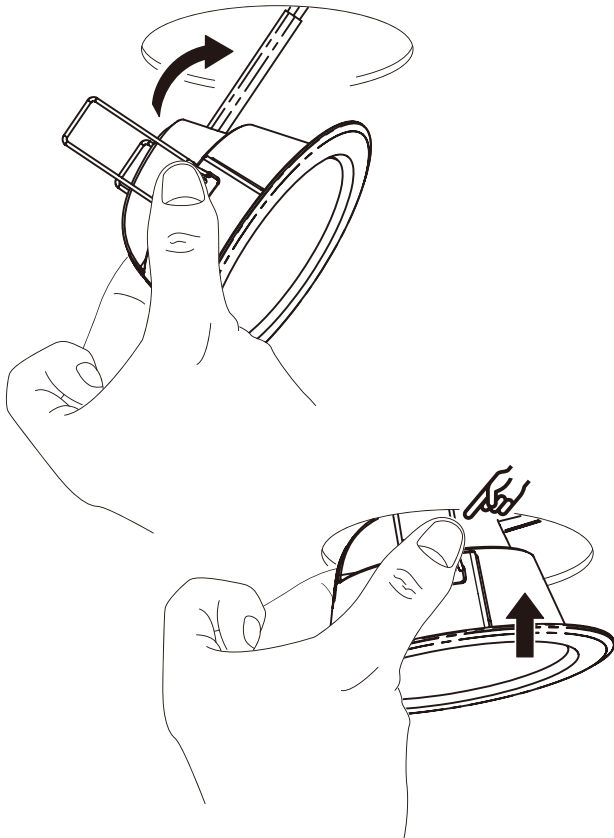

7

部件名称 Part name	有害物质 Hazardous substance					
	铅(Pb) Lead (Pb)	汞(Hg) Mercury (Hg)	镉(Cd) Cadmium (Cd)	六价铬 (Cr(VI)) Hexavalent Chromium (Cr (VI))	多溴联苯 (PBB) Polybrominated biphenyls (PBB)	多溴二苯醚(PBDE) Polybrominated diphenyl ethers (PBDE)
电源线组 Cord set	X	0	0	0	0	0
电子部件 Electronics	X	0	0	0	0	0

本表格依据SJ/T 11364的规定编制
This table is prepared according to provisions of SJ/T 11364.
O: 表示该有害物质在该部件所有均质材料中的含量均在GB/T 26572规定的限量要求以下。
O: Indicates that said hazardous substance contained in all of the homogeneous materials for this part is below the limit requirement of GB/T 26572.
X: 表示该有害物质至少在该部件的某一均质材料中的含量超出GB/T 26572规定的限量要求。
X: Indicates that said hazardous substance contained in at least one of the homogeneous materials for this part is above the limit requirement of GB/T 26572.

8