

CN

LAGAN

105.090.07



Design and Quality
IKEA of Sweden

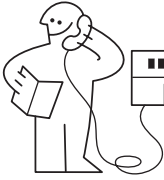

ENGLISH

For the IKEA appointed Authorized Service Centre, please refer to www.IKEA.com and select your local store for phone numbers and opening times.

ENGLISH

4

Contents

Safety information	4	Hints and tips	18
Safety instructions	6	Care and cleaning	19
Product description	7	Troubleshooting	22
Control panel	8	Technical information	25
Programme selection	9	Environmental concerns	26
Basic settings	11	IKEA GUARANTEE	28
Before first use	14		
Daily use	16		

Safety information

Please be sure to operate the appliance in accordance with the supplied instructions otherwise safety incidents may occur. Before the installation and use of the appliance, carefully read the supplied instructions. The manufacturer is not responsible for any injuries or damage that are the result of incorrect installation or usage. Always keep the instructions in a safe and accessible location for future reference.

Juveniles and vulnerable people safety

- The juveniles aged under 8 years shall not use this appliance. This appliance can be used by juveniles aged from 8 years and above and persons with reduced physical, sensory or mental capabilities or lack of experience and knowledge if they have been given supervision or instruction by their guardians with relevant experience and knowledge concerning the use of the appliance in a safe way and understand the hazards involved.
- Juveniles and persons with reduced physical, sensory or mental capabilities shall be kept away unless continuously supervised by their guardians.
- Do not let juveniles play with the appliance.
- Keep detergents away from juveniles.

- Keep juveniles and pets away from the appliance when the door is open.
- Juveniles and persons with reduced physical, sensory or mental capabilities or lack of experience and knowledge shall not carry out cleaning and user maintenance of the appliance.

General Safety

- This appliance is intended to be used in household and similar applications such as:
 - farm houses; staff kitchen areas in shops, offices and other working environments;
 - by clients in hotels, motels, bed & breakfast and other residential type environments.
- Do not change the specification of this appliance.
- The operating water pressure (minimum and maximum) must be between 0.5 (0.05) / 8 (0.8) bar (MPa)
- Follow the maximum number of 13 place settings.
- If the supply cord is damaged, it must be replaced by the manufacturer, its Authorised Service Centre or similarly qualified persons in order to avoid a hazard.
- **WARNING:** Knives and other utensils with sharp points must be loaded in the basket with their points down or placed in a horizontal position.
- Do not leave the appliance with the open door unattended to avoid stepping accidentally onto it.
- Before any maintenance operation, deactivate the appliance and disconnect the mains plug from the socket.
- Do not use high pressure water sprays and/or steam to clean the appliance.
- If the appliance has ventilation openings in the base, they must not be covered e.g. by a carpet.

- The appliance is to be connected to the water mains using the new supplied hose-sets. Old hose sets must not be reused.

Safety instructions

Installation

- ⚠ **Warning!** Only a qualified person must install this appliance.
- Remove all the packaging.
- Do not install or use a damaged appliance.
- Do not use the appliance before installing it in the built-in structure due to safety manner.
- Follow the installation instructions supplied with the appliance.
- Always take care when moving the appliance as it is heavy. Always use safety gloves and enclosed footwear.
- Do not install or use the appliance where the temperature is less than 0 °C.
- Install the appliance in a safe and suitable place that meets installation requirements.

Electrical connection

- ⚠ **Warning!** Risk of fire and electric shock.
- The appliance must be earthed.
- Make sure that the parameters on the rating plate are compatible with the electrical ratings of the mains power supply.
- Always use a correctly installed shockproof socket.
- Do not use multi-plug adapters and extension cables.
- Make sure not to cause damage to the mains plug and to the mains cable. Should the mains cable need to be replaced, this must be carried out by our Authorised Service Centre.
- Connect the mains plug to the mains socket only at the end of the installation.

Make sure that there is access to the mains plug after the installation.

- Do not pull the mains cable to disconnect the appliance. Always pull the mains plug.
- This appliance is fitted with a 10 A mains plug.

Water connection

- Do not cause damage to the water hoses.
- Before connection to new pipes, pipes not used for a long time, where repair work has been carried out or new devices fitted (water meters, etc.), let the water flow until it is clean and clear.
- Ensure that there are no visible water leaks during and after the first use of the appliance.
- The water inlet hose has a safety valve and a sheath with an inner mains cable.

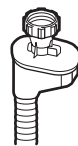

- ⚠ **Warning!** Dangerous voltage.

- If the water inlet hose is damaged, immediately close the water tap and disconnect the mains plug from the mains socket. Contact the Authorised Service Centre to replace the water inlet hose.

Use

- Do not put flammable products or items that are wet with flammable products in, near or on the appliance.
- Dishwasher detergents are dangerous. Follow the safety instructions on the detergent packaging.
- Do not drink and play with the water in the appliance.
- Do not remove the dishes from the appliance until the programme is complete. Some detergent may remain on the dishes.
- Do not store items or apply pressure on the open door of the appliance.
- The appliance can release hot steam if you open the door while a programme operates.

Internal lighting



Warning! Risk of injury.

- Concerning the lamp(s) inside this product and spare part lamps sold separately: These lamps are intended to withstand extreme physical conditions in household appliances, such as temperature, vibration, humidity, or are

intended to signal information about the operational status of the appliance. They are not intended to be used in other applications and are not suitable for household room illumination.

- To replace the internal lighting, contact the Authorised Service Centre.

Service

- To repair the appliance contact the Authorised Service Centre. Use original spare parts only.
- Please note that self-repair or non-professional repair can have safety consequences and might void the guarantee.

Disposal



Warning! Risk of injury or suffocation.

- Disconnect the appliance from the mains supply.
- Cut off the mains cable and discard it.
- Remove the door catch to prevent children and pets to get closed in the appliance.

Product description



The graphics below is just a general product overview. For more detailed information please refer to other chapters and/or documents provided with the appliance.

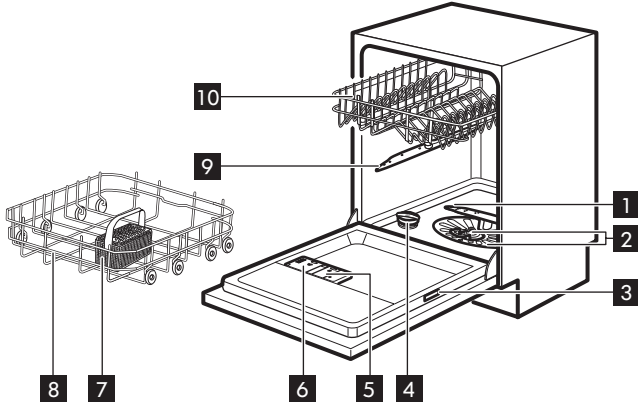



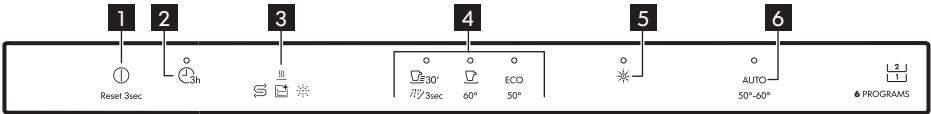

- 1 Lower spray arm
- 2 Filters
- 3 Rating plate
- 4 Salt container
- 5 Rinse aid dispenser
- 6 Detergent dispenser
- 7 Cutlery basket
- 8 Lower basket
- 9 Upper spray arm
- 10 Upper basket

Control panel



- 1 On/Off button / Reset button
- 2 Delay start button
- 3 Indicators
- 4 Programme buttons
- 5 Power Clean button
- 6 AUTO programme button

Indicators

Indicator	Description
	Rinse aid indicator. It is on when the rinse aid dispenser needs refilling. Refer to " Before first use ".
	Salt indicator. It is on when the salt container needs refilling. Refer to " Before first use ".
	Machine Care indicator. It is on when the appliance needs internal cleaning with the Machine Care programme. Refer to " Care and cleaning ".
	Drying phase indicator. It is on when a programme with the drying phase is selected. It flashes when the drying phase operates. Refer to " Programme selection ".

Programme selection

Programmes

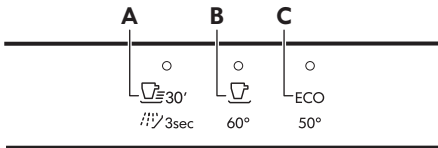

- A.
 - Quick 30' is the shortest programme suitable for washing a load with fresh and light soil.
 - Rinse & Hold is a programme for rinsing off food remains from the dishes. It prevents odours forming in the appliance. Do not use detergent with this programme.
- B. 90 Minutes is a programme suitable for washing and drying normally soiled items.
- C. ECO is the longest programme offering the most efficient use of energy and

water consumption for crockery and cutlery with normal soil. This is the standard programme for test institutes.

Power Clean

 Power Clean improves the washing results of the selected programme. The option increases the wash temperature and duration.







The Power Clean option is applicable to the following programmes: Quick 30', 90 Minutes and ECO.

AUTO



The AUTO program automatically adjusts the wash cycle to the type of load.

The appliance senses the degree of soil and the amount of dishes in the baskets. It adjusts the temperature and quantity of water as well as the wash duration.

Programs overview

Programme	Type of load	Degree of soil	Programme phases	Options
 30'	<ul style="list-style-type: none"> • Crockery • Cutlery 	<ul style="list-style-type: none"> • Fresh 	<ul style="list-style-type: none"> • Wash 50 °C • Intermediate rinse • Final rinse 45 °C • AutoOpen 	<ul style="list-style-type: none"> • 
	<ul style="list-style-type: none"> • All types of loads 	<ul style="list-style-type: none"> • All degrees of soil 	<ul style="list-style-type: none"> • Prewash 	Options are not applicable to this programme.
	<ul style="list-style-type: none"> • Crockery • Cutlery • Pots • Pans 	<ul style="list-style-type: none"> • Normal • Lightly dried-on 	<ul style="list-style-type: none"> • Wash 60 °C • Intermediate rinse • Final rinse 55 °C • Drying • AutoOpen 	<ul style="list-style-type: none"> • 
ECO	<ul style="list-style-type: none"> • Crockery • Cutlery • Pots • Pans 	<ul style="list-style-type: none"> • Normal • Lightly dried-on 	<ul style="list-style-type: none"> • Prewash • Wash 50 °C • Intermediate rinse • Final rinse 55 °C • Drying • AutoOpen 	<ul style="list-style-type: none"> • 
AUTO	<ul style="list-style-type: none"> • Crockery • Cutlery • Pots • Pans 	The programme adjusts to all degrees of soil.	<ul style="list-style-type: none"> • Prewash • Wash 50 - 60 °C • Intermediate rinse • Final rinse 60 °C • Drying • AutoOpen 	Options are not applicable to this programme.
Machine Care	<ul style="list-style-type: none"> • No load 	The programme cleans the appliance interior. Refer to " Care and cleaning ".	<ul style="list-style-type: none"> • Wash 70 °C • Intermediate rinse • Final rinse • AutoOpen 	Options are not applicable to this programme.

Consumption values

Programme 1) 2)	Water (l)	Energy (kWh)	Duration (min)
 30'	9.2 - 11.2	0.556 - 0.68	30
	3.4 - 4.2	0.012 - 0.015	15

Programme ^{1) 2)}	Water (l)	Energy (kWh)	Duration (min)
	9.6 - 11.7	0.886 - 1.083	90
ECO	9.9	0.936	227
AUTO	9 - 12.8	0.694 - 1.223	120 - 170
Machine Care	8.8 - 10.7	0.46 - 0.562	60

1) The pressure and the temperature of the water, the variations of the mains supply, the options, the quantity of dishes and the degree of soil can change the values.

2) The values for programmes other than ECO are indicative only.

Information for test institutes

To receive the necessary information for conducting performance tests (e.g. according to GB/T 20290-2016), send an email to:

info.test@dishwasher-production.com

In your request, include the product number code (PNC) from the rating plate.

For any other questions regarding your dishwasher, refer to the service book provided with your appliance.

Basic settings

You can configure the appliance by changing basic settings according to your needs.

Number	Settings	Values	Description ¹⁾
1	Water hardness	From level 1 to level 10 (default: 5)	Adjust the level of the water softener according to the water hardness in your area.
2	Rinse aid empty notification	On (default) Off	Activate or deactivate the rinse aid indicator.
3	End sound	On Off (default)	Activate or deactivate the acoustic signal for the end of a programme.
4	Auto door open	On (default) Off	Activate or deactivate the AutoOpen.
5	Key tones	On (default) Off	Activate or deactivate the sound of the buttons when pressed.

1) For more details, refer to the information provided in this chapter.

You can change the basic settings in setting mode.

When the appliance is in setting mode, the indicators on the control panel represent

available settings. For each setting, a dedicated indicator flashes:

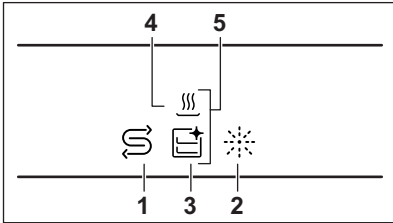

The water softener should be adjusted according to the hardness of the water in your area. Your local water authority can advise you on the hardness of the water in your area. It is important to set the right level of the water softener to assure good washing results.

i Softening hard water increases the consumption of water and energy as well as the programme duration. The higher the level of water softener, the higher the consumption and the longer the duration.

The water softener

The water softener removes minerals from the water supply, which would have a negative effect on the washing results and on the appliance.

The higher the content of these minerals, the harder your water is. Water hardness is measured in equivalent scales.

Water hardness

German degrees (°dH)	French degrees (°fH)	mmol/l	Clarke degrees	Water softener level
47 - 50	84 - 90	8.4 - 9.0	58 - 63	10
43 - 46	76 - 83	7.6 - 8.3	53 - 57	9
37 - 42	65 - 75	6.5 - 7.5	46 - 52	8
29 - 36	51 - 64	5.1 - 6.4	36 - 45	7
23 - 28	40 - 50	4.0 - 5.0	28 - 35	6
19 - 22	33 - 39	3.3 - 3.9	23 - 27	5 1)
15 - 18	26 - 32	2.6 - 3.2	18 - 22	4
11 - 14	19 - 25	1.9 - 2.5	13 - 17	3
4 - 10	7 - 18	0.7 - 1.8	5 - 12	2
<4	<7	<0.7	< 5	1 2)

1) Factory setting.

2) Do not use salt at this level.

Regardless of the type of detergent used, set the proper water hardness level to keep the salt refill indicator active.

i Multi-tabs containing salt are not effective enough to soften hard water.

The rinse aid empty notification

The rinse aid helps to dry the dishes without streaks and stains. It is automatically released during the hot rinse phase.

When the rinse aid chamber is empty, the rinse aid indicator is turned on notifying to refill rinse aid. If the drying results are satisfactory while using multi-tablets only, it is possible to deactivate the notification for refilling rinse aid. However, for best drying performance, always use rinse aid.

If standard detergent or multi-tablets without rinse aid are used, activate the notification to keep the rinse aid refill indicator active.

End sound

You can activate an acoustic signal that sounds when the programme is completed.

-  Acoustic signals sound also when a malfunction of the appliance occurs. It is not possible to deactivate these signals.

AutoOpen

AutoOpen improves the drying results with less energy consumption. The appliance door opens automatically during the drying phase and remains ajar.

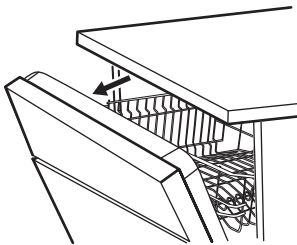

AutoOpen is automatically activated with all programmes other than Rinse & Hold.

 **Caution!** Do not try to close the appliance door within 2 minutes after automatic opening. This can cause damage to the appliance.

 **Caution!** If children, pets or people with disabilities have access to the appliance, deactivate AutoOpen. The automatic opening of the door may pose a danger and expose possible hazards inside the appliance (such as knives, sharp objects, chemicals).

Key tones





The buttons on the control panel make a click sound when you press them. You can deactivate this sound.

Setting mode

How to enter setting mode

You can enter setting mode before starting a programme. You cannot enter setting mode while the programme is running.

To enter setting mode, press and hold simultaneously  and **ECO** for about 3 seconds.

- The light related to  and the indicator  flash.
- The indicators ,  and  are on.
- The lights related to the programme buttons are on.

How to navigate in setting mode

You can navigate in setting mode using programme buttons.

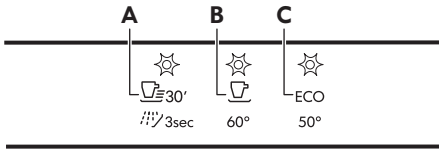

- A. Previous button
- B. OK button
- C. Next button

Use **Previous** and **Next** to switch between the basic settings and to change their value.

Use **OK** to enter the selected setting and to confirm changing its value.

How to change a setting

Make sure the appliance is in setting mode.

1. Press **Previous** or **Next** until the indicator dedicated to the desired setting flashes.

The light related to indicates the current setting value:

- For the settings with two values (on and off), the light is either on (= the

setting is on) or off (= the setting is off).

- For the settings with multiple values (levels), the light flashes. The number of flashes indicates the current setting value (e.g. 5 flashes + pause + 5 flashes... = level 5).
2. Press **OK** to enter the setting.
 - The indicator related to the setting is on.
 - The other indicators are off.
 - The light related to indicates the current setting value.
 3. Press **Previous** or **Next** to change the value.
 4. Press **OK** to confirm the setting.
 - The new setting is saved.
 - The appliance returns to the setting selection.
 5. Press and hold simultaneously and **ECO** for about 3 seconds to exit setting mode.

The appliance returns to the programme selection.

The saved settings remain valid until you change them again.

Before first use

1. **Make sure that the current level of the water softener agrees with the hardness of the water supply. If not, adjust the level of the water softener.**
2. Fill the salt container.
3. Fill the rinse aid dispenser.
4. Open the water tap.
5. Start the programme Quick 30' to remove any residuals from the manufacturing process. Do not use detergent and do not put dishes in the baskets.

After starting the programme, the appliance recharges the resin in the water softener for up to 5 minutes. The washing phase starts only after this procedure is complete. The procedure is repeated periodically.

The salt container

Caution! Use rough salt designed for dishwashers only. Fine salt increases the risk of corrosion.

The salt is used to recharge the resin in the water softener and to assure good washing results in daily use.

Filling the salt container

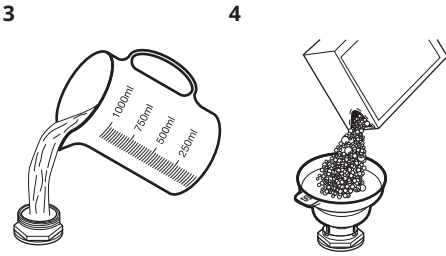
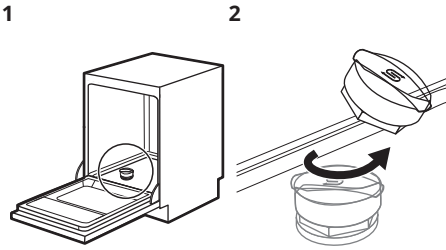

Put 1 litre of water in the salt container (only for the first time).
 Put 1 kg of salt in the salt container.

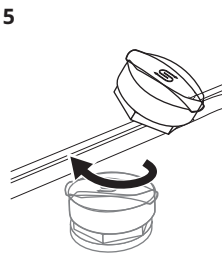

Turn the cap of the salt container clockwise to close the salt container.

⚠ Caution! Water and salt may come out of the salt container when you fill it. After you fill the salt container, immediately start a programme to prevent corrosion.

Filling the rinse aid dispenser

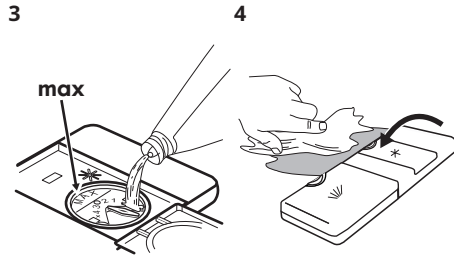
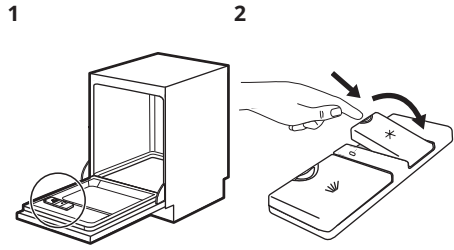

To adjust the released quantity of rinse aid, turn the selector between position 1 (lowest quantity) and position 4 (highest quantity).

Daily use

1. Open the water tap.
2. Press and hold  until the appliance is activated.
3. Fill the salt container if it is empty.
4. Fill the rinse aid dispenser if it is empty.
5. Load the baskets.
6. Add the detergent.
7. Select and start a programme.
8. Close the water tap when the programme is complete.

Using the detergent

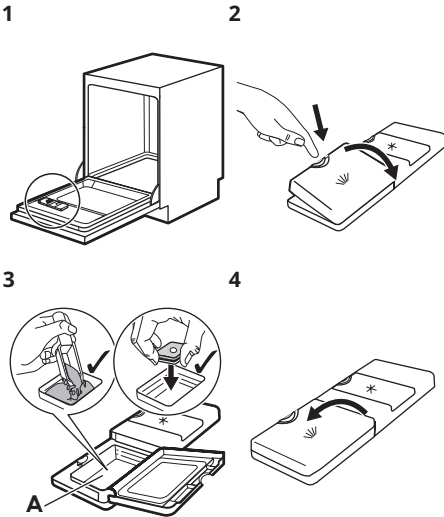

Put the detergent or the multi-tablet in compartment (A).

If the programme has a prewash phase, put a small quantity of detergent on the inner part of the appliance door.

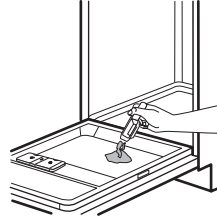

When you use multi-tablets that contain salt and rinse aid, it is not necessary to fill the salt container and the rinse aid dispenser.



- Adjust the water softener to the lowest level.
- Set the rinse aid dispenser to the lowest position.

 Multi-tabs containing salt are not effective enough to soften hard water.

How to select and start a programme

1. Press the button dedicated to the programme you want to set. The light related to the button flashes.
2. Activate Power Clean if desired.
3. Close the appliance door to start the programme.

How to select and start the programme

1. To select , press and hold  for 3 seconds.



The light related to the button flashes.

 Power Clean is not applicable to this programme.

2. Close the appliance door to start the programme.

How to activate Power Clean

1. Select a programme.
2. Press . The light related to the button is on.

-  Power Clean is not a permanent option and must be activated every time before you start a programme.
-  It is not possible to activate or deactivate Power Clean while a programme is running.
-  Activating Power Clean increases the water and energy consumption as well as the programme duration.

How to select and start the programme AUTO

1. Press **AUTO**.

The light related to the button is on.

-  Power Clean is not applicable to this programme.

2. Close the appliance door to start the programme.

The appliance senses the type of load and adjusts a suitable wash cycle.

How to delay the start of a programme

You can delay the start of the selected programme by 3 hours.

1. Select a programme.

2. Press .

The light related to the button is on.

3. Close the appliance door to start the countdown.

During the countdown, it is not possible to change the programme selection.

When the countdown is complete, the programme starts.

How to cancel the delay start while the countdown operates

Press and hold  for about 3 seconds. The appliance returns to the programme selection.

-  If you cancel the delay start, you have to select the programme again.

How to cancel a running programme

Press and hold  for about 3 seconds. The appliance returns to the programme selection.

-  Make sure that there is detergent in the detergent dispenser before you start a new programme.

Opening the door while the appliance operates

Opening the door while a programme is running stops the appliance. It may affect the energy consumption and the programme duration. After closing the door, the appliance continues from the point of interruption.

-  If the door is opened for more than 30 seconds during the drying phase, the running programme ends. It does not happen if the door is opened by AutoOpen function.

The Auto Off function

This function saves energy by switching the appliance off when it is not operating.

The function activates automatically:

- After up to 15 seconds once the programme is complete.
- After 5 minutes if a programme was not started.

End of the programme

When the programme is complete, the Auto Off function switches the appliance off automatically.

All buttons are inactive except for the on/off button.

Hints and tips

General

Follow the hints below to ensure optimal cleaning and drying results in daily use and to protect the environment.

- Washing dishes in the dishwasher as instructed in the user manual usually consumes less water and energy than washing dishes by hand.
- Load the dishwasher to its full capacity to save water and energy. For best cleaning results, arrange items in the baskets as instructed in the user manual and do not overload the baskets.
- Do not pre-rinse dishes by hand. It increases the water and energy consumption. When needed, select a programme with a prewash phase.
- Remove larger residues of food from the dishes and empty cups and glasses before putting them inside the appliance.
- Soak or slightly scour cookware with firmly cooked-on or baked-on food before washing it in the appliance.
- Make sure that items in the baskets do not touch or cover each other. Only then can the water completely reach and wash the dishes.
- You can use dishwasher detergent, rinse aid and salt separately or you can use the multi-tablets (e.g. "All in 1"). Follow the instructions on the packaging.
- Select a programme according to the type of load and the degree of soil. ECO offers the most efficient use of water and energy consumption.
- To prevent limescale buildup inside the appliance:
 - Refill the salt container whenever necessary.
 - Use the recommended dosage of the detergent and rinse aid.
 - Make sure that the current level of the water softener agrees with the hardness of the water supply.
 - Follow the instructions in the chapter "**Care and cleaning**".

Using salt, rinse aid and detergent

- Only use salt, rinse aid and detergent designed for dishwasher. Other products can cause damage to the appliance.
- In areas with hard and very hard water, we recommend to use basic dishwasher detergent (powder, gel, tablets containing no additional agents), rinse aid and salt separately for optimal cleaning and drying results.
- Detergent tablets do not fully dissolve with short programmes. To prevent detergent residues on the tableware, we recommend that you use tablets with long programmes.
- Always use the correct quantity of detergent. Insufficient dosage of detergent can result in poor cleaning results and hard-water filming or spotting on the items. Using too much detergent with soft or softened water results in detergent residues on the dishes. Adjust the amount of detergent based on the water hardness. Refer to the instructions on the detergent packaging.
- Always use the correct quantity of rinse aid. Insufficient dosage of rinse aid decreases the drying results. Using too much rinse aid results in bluish layers on the items.
- Make sure that the water softener level is correct. If the level is too high, the increased quantity of salt in the water might result in rust on cutlery.

What to do if you want to stop using multi-tablets

Before you start using separately detergent, salt and rinse aid, complete the following steps:

1. Set the highest level of the water softener.
2. Make sure that the salt and rinse aid containers are full.

3. Start the Quick 30' programme. Do not add detergent and do not put dishes in the baskets.
4. When the programme is completed, adjust the water softener according to the water hardness in your area.
5. Adjust the released quantity of rinse aid.

Before starting a programme

Before you start the selected programme, make sure that:

- The filters are clean and correctly installed.
- The cap of the salt container is tight.
- The spray arms are not clogged.
- There is enough salt and rinse aid (unless you use multi-tablets).
- The arrangement of the items in the baskets is correct.
- The programme is suitable to the type of load and the degree of soil.
- The correct quantity of detergent is used.

Loading the baskets

 Refer to the supplied leaflet with examples of the load of the baskets.

- Always use the whole space of the baskets.
- Use the appliance to wash dishwasher-safe items only.
- Do not wash in the appliance items made of wood, horn, aluminium, pewter and

copper as they could crack, warp, get discoloured or pitted.

- Do not wash in the appliance items that can absorb water (sponges, household cloths).
- Remove remaining food from the items.
- Soak cookware with burnt-on food before washing it in the appliance.
- Put hollow items (cups, glasses and pans) with the opening facing downwards.
- Make sure that cutlery and dishes do not bond together. Mix spoons with other cutlery.
- Make sure that glasses do not touch each other.
- Put cutlery and small items in the cutlery basket.
- Put light items in the upper basket. Make sure that the items do not move freely.
- Make sure that the spray arm can move freely before you start a programme.

Unloading the baskets

1. Let the tableware cool down before you remove it from the appliance. Hot items can be easily damaged.
2. First remove items from the lower basket, then from the upper basket.

 After the programme is completed, water can still remain on the inside surfaces of the appliance.

Care and cleaning

 **Warning!** Before any maintenance other than running the programme Machine Care, deactivate the appliance and disconnect the mains plug from the main socket.

 Dirty filters and clogged spray arms negatively affect the washing results. Check these elements regularly and, if necessary, clean them.

Machine Care

Machine Care is a programme designed to clean the appliance interior with optimal

results. It removes limescale and grease buildup.

When the appliance senses the need for cleaning, the indicator  is on. Start the Machine Care programme to clean the appliance interior.

How to start the Machine Care programme

 Before starting the Machine Care programme, clean the filters and spray arms.

1. Use a descaler or a cleaning product designed specifically for dishwashers. Follow the instructions on the packaging. Do not put dishes in the baskets.
2. Press and hold simultaneously  and **AUTO** for about 3 seconds.

The indicators  and  flash.

3. Close the appliance door to start the programme.

When the programme is complete, the indicator  is off.

Internal cleaning

- Carefully clean the appliance, including the rubber gasket of the door, with a soft damp cloth.
- Do not use abrasive products, abrasive cleaning pads, sharp tools, strong chemicals, scourer or solvents.
- To maintain the performance of your appliance, use a cleaning product designed specifically for dishwashers at least once every two months. Carefully follow the instructions on the packaging of the product.
- For optimal cleaning results, start the Machine Care programme.

External cleaning

- Clean the appliance with a moist soft cloth.
- Only use neutral detergents.
- Do not use abrasive products, abrasive cleaning pads or solvents.

Cleaning the filters

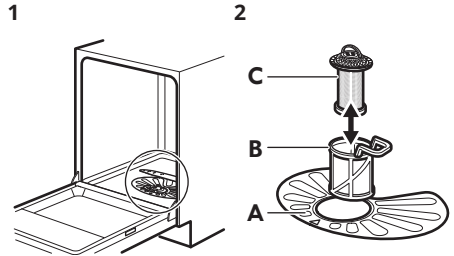

1 Make sure that there are no residues of food or soil in or around the edge of the sump.

2 The filter system is made of three parts.

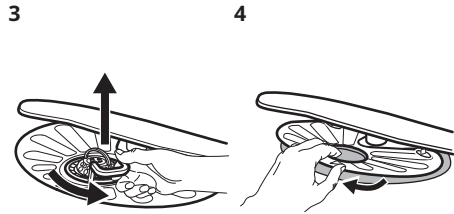

3 To remove filters (B) and (C), turn the handle counterclockwise and pull it upwards. Remove the filter (C) out of filter (B). Wash the filters with water.

4 Remove the flat filter (A). Wash the filter with water.

5

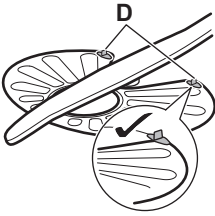

Put the flat filter (A) back in place. Make sure that it is correctly positioned under the 2 guides (D).

i An incorrect position of the filters can cause bad washing results and damage to the appliance

6

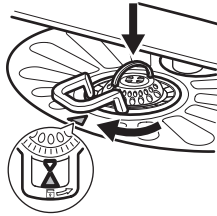

Reassemble the filters (B) and (C). Put them back in the filter (A). Turn the handle clockwise until it locks.

Cleaning the lower spray arm

We recommend to clean the lower spray arm regularly to prevent soil from clogging the holes. Clogged holes can cause unsatisfactory washing results.

1

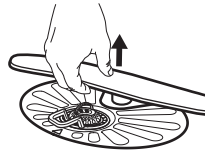

To remove the lower spray arm, pull it upwards.

2

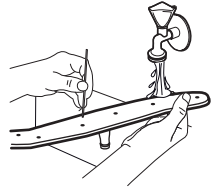

Wash the spray arm under running water. Use a thin pointed tool, e.g. a toothpick, to remove particles of soil from the holes.

3

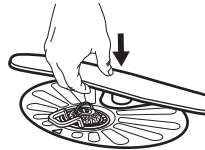

To install the spray arm back, press it downwards.

Cleaning the filter of the inlet hose

1

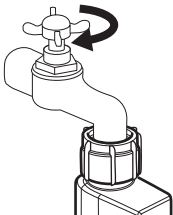

Close the water tap.

2

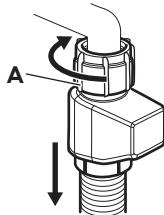

Disconnect the hose. Turn the fastener A clockwise.

3

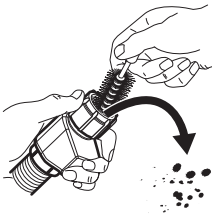

Clean the filter of the inlet hose.

4

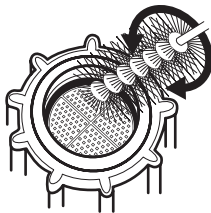

Troubleshooting

⚠ Warning! Improper repair of the appliance may pose a danger to the safety of the user. Any repairs must be performed by qualified personnel.

Refer to the below table for information on possible problems.

The majority of problems that may occur can be solved without the need to contact an Authorised Service Centre.

Problem and alarm code	Possible cause and solution
You cannot activate the appliance.	<ul style="list-style-type: none"> • Make sure that the mains plug is connected to the mains socket. • Make sure that there is no damaged fuse in the fuse box.
The programme does not start.	<ul style="list-style-type: none"> • Make sure that the appliance door is closed. • If the delay start is set, cancel the setting or wait for the end of the countdown. • The appliance recharges the resin inside the water softener. The duration of the procedure is approximately 5 minutes.
The appliance does not fill with water. <ul style="list-style-type: none"> • The lights related to the programme buttons flash 1 time intermittently. • An acoustic signal sounds intermittently. 	<ul style="list-style-type: none"> • Make sure that the water tap is open. • Make sure that the pressure of the water supply is not too low. For this information, contact your local water authority. • Make sure that the water tap is not clogged. • Make sure that the filter in the inlet hose is not clogged. • Make sure that the inlet hose has no kinks or bends.
The appliance does not drain the water. <ul style="list-style-type: none"> • The lights related to the programme buttons flash 2 times intermittently. • An acoustic signal sounds intermittently. 	<ul style="list-style-type: none"> • Make sure that the sink spigot is not clogged. • Make sure that the interior filter system is not clogged. • Make sure that the drain hose has no kinks or bends.
The anti-flood device is on. <ul style="list-style-type: none"> • The lights related to the programme buttons flash 3 times intermittently. • An acoustic signal sounds intermittently. 	<ul style="list-style-type: none"> • Close the water tap. • Make sure that the appliance is correctly installed. • Make sure the baskets are loaded as instructed in the user manual.

Problem and alarm code	Possible cause and solution
The appliance stops and starts more times during operation.	<ul style="list-style-type: none"> • It is normal. It provides optimal cleaning results and energy savings.
The programme lasts too long.	<ul style="list-style-type: none"> • If the delay start option is set, cancel the delay setting or wait for the end of the countdown. • Activating Power Clean increases the programme duration.
Small leak from the appliance door.	<ul style="list-style-type: none"> • The appliance is not levelled. Loosen or tighten the adjustable feet (if applicable). • The appliance door is not centred on the tub. Adjust the rear foot (if applicable).
The appliance door is difficult to close.	<ul style="list-style-type: none"> • The appliance is not levelled. Loosen or tighten the adjustable feet (if applicable). • Parts of the tableware are protruding from the baskets.
The appliance door opens during the wash cycle.	<ul style="list-style-type: none"> • The AutoOpen is activated. This function opens the appliance door during the drying phase to improve the drying performance and let the dishes cool down. The door remains ajar. <ul style="list-style-type: none"> – The duration of the drying phase and the door opening time vary depending on the selected programme and options. If you don't want the door to automatically open, deactivate AutoOpen. Refer to "Settings".
Rattling or knocking sounds from the inside of the appliance.	<ul style="list-style-type: none"> • The tableware is not properly arranged in the baskets. Refer to basket loading leaflet. • Make sure that the spray arms can rotate freely.
The appliance trips the circuit-breaker.	<ul style="list-style-type: none"> • The amperage is insufficient to supply simultaneously all the appliances in use. Check the socket amperage and the capacity of the meter or turn off one of the appliances in use. • Internal electrical fault of the appliance. Contact an Authorised Service Centre.

Once you have checked the appliance, deactivate and activate the appliance. If the problem occurs again, contact an Authorised Service Centre.



Warning! We do not recommend using the appliance until the problem has been completely fixed. Unplug the appliance and do not plug it in again until you are certain that it operates correctly.

The dishwashing and drying results are not satisfactory

Problem	Possible cause and solution
<p>Poor washing results.</p>	<ul style="list-style-type: none"> • Refer to "Daily use", "Hints and tips" and the basket loading leaflet. • Use more intensive washing programme. • Activate the Power Clean option to improve the washing results of a selected programme. • Clean spray arm jets and filter. Refer to "Care and Cleaning".
<p>Poor drying results.</p>	<ul style="list-style-type: none"> • Tableware was left for too long inside the closed appliance. Activate AutoOpen to set the automatic opening of the door and to improve the drying performance. • There is no rinse aid or the dosage of rinse aid is not sufficient. Fill the rinse aid dispenser or set the level of rinse aid to a higher level. • The quality of the rinse aid can be the cause. • We recommend to use rinse aid always, even in combination with multi-tablets. • Plastic items may need to be towel dried. • The programme does not have the drying phase. Refer to "Programmes overview".
<p>There are whitish streaks or bluish layers on glasses and dishes.</p>	<ul style="list-style-type: none"> • The released quantity of rinse aid is too high. Adjust the rinse aid level to a lower level. • The quantity of detergent is too high.
<p>There are stains and dry water drops on glasses and dishes.</p>	<ul style="list-style-type: none"> • The released quantity of rinse aid is not sufficient. Adjust the rinse aid level to a higher level. • The quality of the rinse aid can be the cause.
<p>The interior of the appliance is wet.</p>	<ul style="list-style-type: none"> • This is not a defect of the appliance. Humid air condensates on the appliance walls.
<p>Unusual foam during washing.</p>	<ul style="list-style-type: none"> • Use the detergent designed specifically for dishwashers. • There is a leak in the rinse aid dispenser. Contact an Authorised Service Centre.
<p>Traces of rust on cutlery.</p>	<ul style="list-style-type: none"> • There is too much salt in the water used for washing. Refer to "The water softener". • Silver and stainless steel cutlery were placed together. Do not put silver and stainless steel items close together.

Problem	Possible cause and solution
There are residues of detergent in the dispenser at the end of the programme.	<ul style="list-style-type: none"> • The detergent tablet was stuck in the dispenser and therefore was not completely washed away by water. • Water cannot wash away the detergent from the dispenser. Make sure that the spray arms are not blocked or clogged. • Make sure that items in the baskets do not impede the lid of the detergent dispenser from opening.
Odours inside the appliance.	<ul style="list-style-type: none"> • Refer to "Internal cleaning". • Start the Machine Care programme with a descaler or a cleaning product designed for dishwashers.
Limescale deposits on the tableware, on the tub and on the inside of the door.	<ul style="list-style-type: none"> • The level of salt is low, check the refill indicator. • The cap of the salt container is loose. • Your tap water is hard. Refer to "The water softener". • Use salt and set regeneration of the water softener even when multi-functional tablets are used. Refer to "The water softener". • Start the Machine Care programme with a descaler designed for dishwashers. • If limescale deposits still remain, clean the appliance with appliance cleaners which are particularly suitable for this purpose. • Try a different detergent. • Contact the detergent manufacturer.
Dull, discoloured or chipped tableware.	<ul style="list-style-type: none"> • Make sure that only dishwasher-safe items are washed in the appliance. • Load and unload the basket carefully. Refer to the basket loading leaflet. • Place delicate items in the upper basket.

 Refer to "**Before first use**", "**Daily use**", or "**Hints and tips**" for other possible causes.

Technical information

Product type	Fully integrated dishwasher	
Dimensions	Width / height / depth (mm)	596 / 818 - 898 / 550
Electrical connection ¹⁾	Voltage (V)	220 - 240
	Frequency (Hz)	50

Water supply pressure	Min. / max. bar (MPa)	0.5 (0.05) / 8 (0.8)
Water supply	Cold water or hot water ²⁾	max 60 °C
Capacity	Place settings	13

1) Refer to the rating plate for other values.

2) If the hot water comes from alternative source of energy, (e.g. solar panels, aeolian energy), use the hot water supply to decrease energy consumption.

Environmental concerns

Recycle materials with the symbol . Put the packaging in relevant containers to recycle it. Help protect the environment and human health by recycling waste of electrical and electronic appliances. Do not dispose of

appliances marked with the symbol  with the household waste. Return the product to your local recycling facility or contact your municipal office.

Parts Name	Hazardous substances						
	Pb	Hg	Cd	Cr6+	PBBs	PBDEs	
Cabinet	X	O	O	O	O	O	
Tub	O	O	O	O	O	O	
Sump & hydraulics (including pumps, heater & sensors)	X	O	O	O	O	O	
Softener & inner components	X	O	O	O	O	O	
Hydraulic circuit (including tanks)*	X	O	O	O	O	O	
Wiring harnesses	X	O	O	O	O	O	
Door	O	O	O	O	O	O	
Innerdoor (stainless steel inner door, sealing, bitumen, detergent dispenser, latch)	X	O	O	O	O	O	
Control panel	X	O	O	O	O	O	
Baskets & sprayarms	O	O	O	O	O	O	
Fittings: screws, brackets & plastic parts needed for installation as reported in the assembly instruction	X	O	O	O	O	O	

Note:

1. This table is compiled according to SJ/T11364-2014.
2. O means that this kind of hazardous substance content in all of the homogenous materials of this part is under the limitations regulated in GB/T26572-2011.
3. X means that this kind of hazardous substance content in at least one homogenous material of this part exceeds the limitations regulated in GB/T26572-2011.
4. For these parts with X in the above table, there is no replacement solution due to technological limitations in the industry, however, this may change with technological improvement.
5. If a part is marked with *, it means that it does not apply to all models, the actual parts depend on specific models.
6. Under normal usage conditions, the environment-friendly usage period is 15 years.

IKEA GUARANTEE

How long is the IKEA guarantee valid?

This guarantee is valid for two (2) years from the original date of purchase of your appliance at IKEA. The original sales receipt is required as proof of purchase. If service work is carried out under guarantee, this will not extend the guarantee period for the appliance.

Who will execute the service?

IKEA service provider will provide the service through its own service operations or authorized service partner network.

What does this guarantee cover?

The guarantee covers faults of the appliance, which have been caused by faulty construction or material faults from the date of purchase from IKEA. This guarantee applies to domestic use only. The exceptions are specified under the headline "What is not covered under this guarantee?" Within the guarantee period, the costs to remedy the fault e.g. repairs, parts, labour and travel will be covered, provided that the appliance is accessible for repair without special expenditure. On these conditions the respective local regulations are applicable. Replaced parts become the property of IKEA.

What will IKEA do to correct the problem?

IKEA appointed Service Provider will examine the product and decide, at its sole discretion, if it is covered under this guarantee. If considered covered, IKEA Service Provider or its authorized service partner through its own service operations, will then, at its sole discretion, either repair the defective product or replace it with the same or a comparable product.

What is not covered under this guarantee?

- Normal wear and tear.
- Deliberate or negligent damage, damage caused by failure to observe operating instructions, incorrect installation or by connection to the wrong voltage, damage caused by chemical or electro-chemical reaction, rust, corrosion or water damage including but not limited to damage caused by excessive lime in the water supply, damage caused by abnormal environmental conditions.
- Consumable parts including batteries and lamps.
- Non-functional and decorative parts which do not affect normal use of the appliance, including any scratches and possible color differences.
- Accidental damage caused by foreign objects or substances and cleaning or unblocking of filters, drainage systems or soap drawers.
- Damage to the following parts: ceramic glass, accessories, crockery and cutlery baskets, feed and drainage pipes, seals, lamps and lamp covers, screens, knobs, casings and parts of casings. Unless such damages can be proved to have been caused by production faults.
- Cases where no fault could be found during a technician's visit.
- Repairs not carried out by our appointed service providers and/or an authorized service contractual partner or where non-original parts have been used.
- Repairs caused by installation which is faulty or not according to specification.
- The use of the appliance in a non-domestic environment i.e. professional use.
- Transportation damages. If a customer transports the product to his home or another address, IKEA is not liable for any damage that may occur during transport. However, if IKEA delivers the product to the customer's delivery address, then damage to the product that occurs during this delivery will be covered by IKEA.
- Cost for carrying out the initial installation of the IKEA appliance.
- However, if an IKEA appointed Service Provider or its authorized service partner

repairs or replaces the appliance under the terms of this guarantee, the appointed Service Provider or its authorized service partner will reinstall the repaired appliance or install the replacement, if necessary.

- All plumbing and electrical installation, are not the responsibility of IKEA, and customer must complete these work before the execution work.

How country law applies

The IKEA guarantee gives you specific legal rights, which cover or exceed all the local legal demands. However these conditions do not limit in any way consumer rights described in the local legislation.

Area of validity

This warranty is valid only in the country where the product has been purchased; the services will be provided in the framework of the guarantee conditions. An obligation to carry out services in the framework of the guarantee exists only if the appliance complies and is installed in accordance with:

- the technical specifications of the country in which the guarantee claim is made;
- the Assembly Instructions and User Manual Safety Information;

The dedicated AFTER SALES for IKEA appliances

Please don't hesitate to contact IKEA appointed Authorized Service Centre to:

- make a service request under this guarantee;
- ask for clarifications on installation of the IKEA appliance in the dedicated IKEA kitchen furniture;
- ask for clarification on functions of IKEA appliances.

To ensure that we provide you with the best assistance, please read carefully the Assembly Instructions and/or the User Manual before contacting us.

How to reach us if you need our service



- **i** The IKEA after sales customer service center will assist you on the phone with basic troubleshooting for your appliances at the time of service call request. Please refer to **www.IKEA.com** and select your local store for local store phone numbers and opening times.

- **i** Before calling us, assure that You have to hand the IKEA article number (8 digit code) and the Serial Number (8 digit code that can be found on the rating plate) for the appliance of which you need our assistance.

- **i** **SAVE THE SALES RECEIPT!** It is your proof of purchase and required for the guarantee to apply. Note that the receipt reports also the IKEA article name and number (8 digit code) for each of the appliances you have purchased.

Do you need extra help?

For any additional questions not related to After Sales of your appliances please contact your nearest IKEA store call centre. We recommend you read the appliance documentation carefully before contacting us.

156805220-A-042021



© Inter IKEA Systems B.V. 2021

21552

AA-2280236-1