

TRÅDFRI

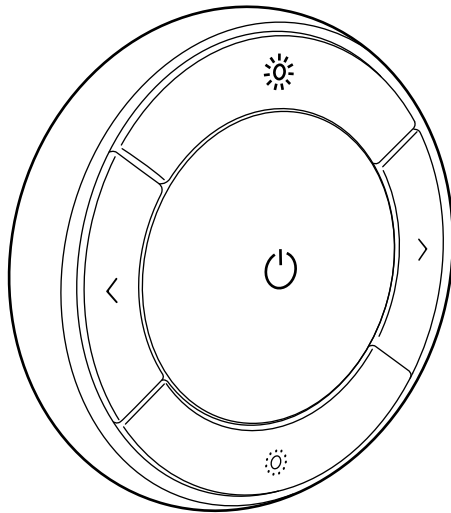

Design and Quality
IKEA of Sweden



ENGLISH

Different materials require different types of fittings. Always choose screws and plugs that are specially suited to the material.

中文

不同的安裝面材質須採用不同的固定安裝螺釘。務必選擇適用的安裝螺釘和螺絲。

繁中

不同材質的牆面,須搭配不同的上牆配件;請選購適合牆面材質的螺絲和壁虎。

한국어

고정할 곳의 소재에 따라 다른 종류의 고정장치를 사용해야 합니다. 반드시 소재에 적합한 나사와 칼브릭을 사용하세요.



日本語

壁の材質により使用できるネジの種類が異なります。壁の材質に合ったネジやネジ固定具を使用してください。

BAHASA INDONESIA

Bahan material yang berbeda memerlukan kelengkapan yang berbeda. Selalu memilih sekrup dan baut yang sesuai dengan bahan material pilihan anda.

BAHASA MALAYSIA

Bahan yang berlainan memerlukan jenis pelengkap yang berlainan. Sentiasa pilih skru dan palam yang paling sesuai dengan bahan.

عربي

المواد المختلفة تتطلب أنواع مختلفة من التركيبات. إختار البراغي والمقابس التي تناسب خاصية المادة.



ไทย

วัสดุพื้นผนังและเพดานมีหลายแบบแตกต่างกัน จึงจำเป็นต้องใช้สกรูหรืออุปกรณ์ยึดต่างชนิดกัน ควรเลือกใช้สกรูและทุกชนิดที่เหมาะสม พื้นผิวที่คุณต้องการติดตั้ง โคมไฟ

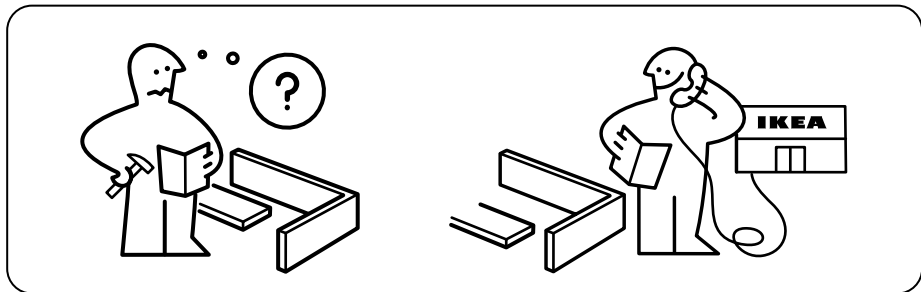
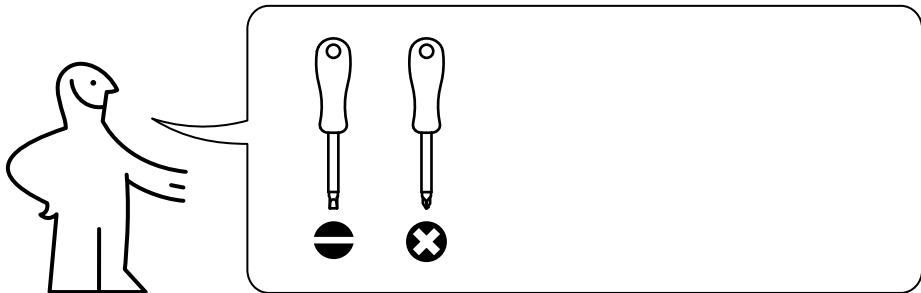

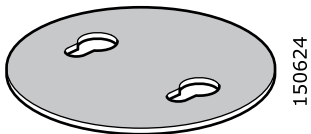

1x

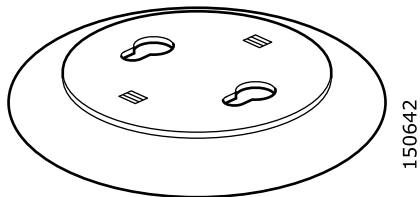

1x

1

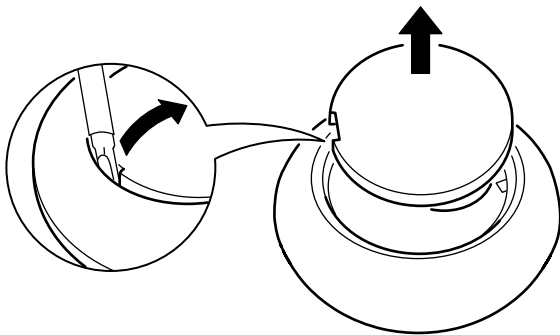

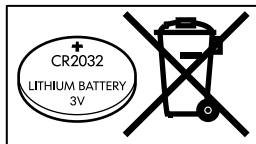
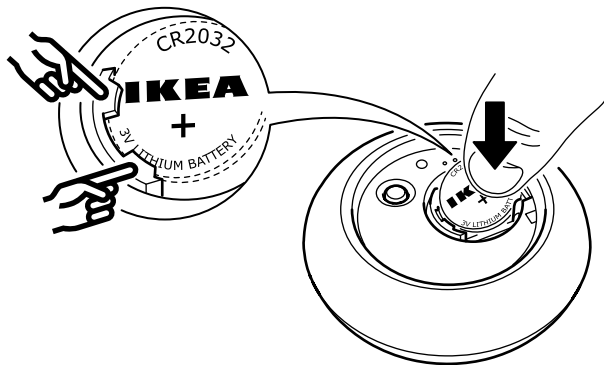

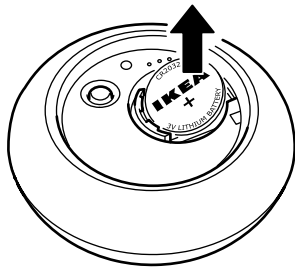
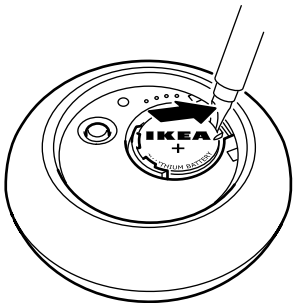



ENGLISH

Keep battery out of childrens reach. To swallow a battery could be fatal. If this happens seek medical attention at once. Before disposal always cover the battery in plastic tape to avoid possible short circuit.

SAVE THESE INSTRUCTIONS.

中文

電池請放在兒童無法觸及的地方。誤吞電池可能致命。萬一發生此類危險，請即刻就醫。請將要丟棄的廢電池放在塑料容器中，以防電池短路。

請牢記。

繁中

須將電池放在孩童接觸不到的地方·以免造成誤食的危險·若發生誤食情況·立即就醫尋求醫療協助·丟棄前·務必用膠帶包覆電池·以免發生短路的危險·

請妥善保存此說明書·

한국어

전지는 어린이의 손이 닿지 않는 곳에 보관하세요. 어린이가 전지를 삼킬 경우 매우 치명적이며, 즉시 치료를 해야 합니다. 합선의 예방을 위해 전지를 폐기할 때는 테이프로 단자를 씌워 주세요. 본 설명서를 잘 보관해 주세요.



日本語

電池はお子さまの手の届かない場所に保管してください。誤って飲み込むと、たいへん危険です。万が一飲み込んでしまった場合はすぐに医師の診察を受けてください。電池を破棄する際は、電池がショートする危険を防ぐため、電池の端子部分にプラスチックテープを貼って絶縁してください。

この説明書は、いつでも参照できるように大切に保管してください。

BAHASA INDONESIA

Jauhkan baterai dari jangkauan anak-anak. Baterai yang tertelan bisa berakibat fatal. Jika ini terjadi, dapatkan bantuan perobatan segera. Sebelum dibuang, balut baterai dengan pita plastik untuk mencegah litar pintas.

SIMPAN PETUNJUK INI.

BAHASA MALAYSIA

Jauhkan bateri daripada kanak-kanak. Bateri yang tertelan boleh menyebabkan kematian. Jika ini berlaku, dapatkan bantuan perubatan segera. Sebelum dibuang, balut bateri dengan pita plastik untuk mengelakkan litar pintas.

SIMPAN ARAHAN INI.

عربي

أبقي البطارية بعيداً عن متناول الأطفال. إبتلاع البطارية يمكن أن يؤدي للموت. وإذا حدث ذلك التمس العناية الطبية على الفور. قبل التخلص من البطارية ينبغي دائماً تغطية البطارية بشريط من البلاستيك لتجنب إلتماس كهربائى محتمل. يرجى الإحتفاظ بهذه التعليمات.



ไทย

เก็บแบตเตอรี่ให้พ้นมือเด็ก การกลืนแบตเตอรี่อาจก่อให้เกิดอันตรายถึงแก่ชีวิต หากเด็กกลืนแบตเตอรี่ ให้นำส่งแพทย์โดยด่วน ก่อนทิ้งแบตเตอรี่ ให้ใช้เทปพลาสติกพันให้เรียบร้อย เพื่อป้องกันการลัดวงจร เก็บคำแนะนำไว้

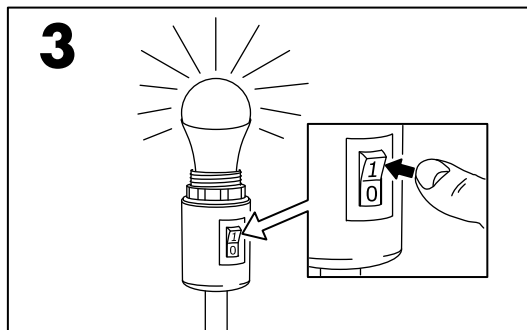
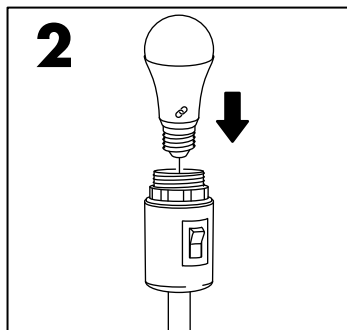
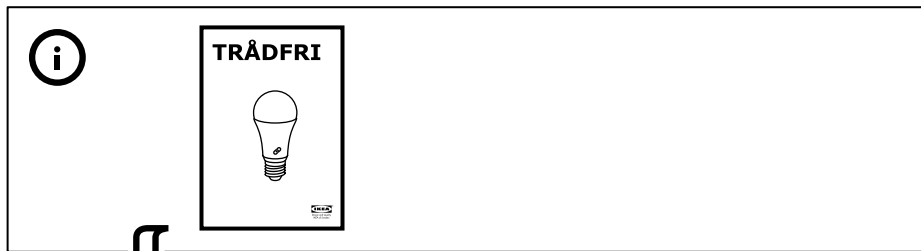

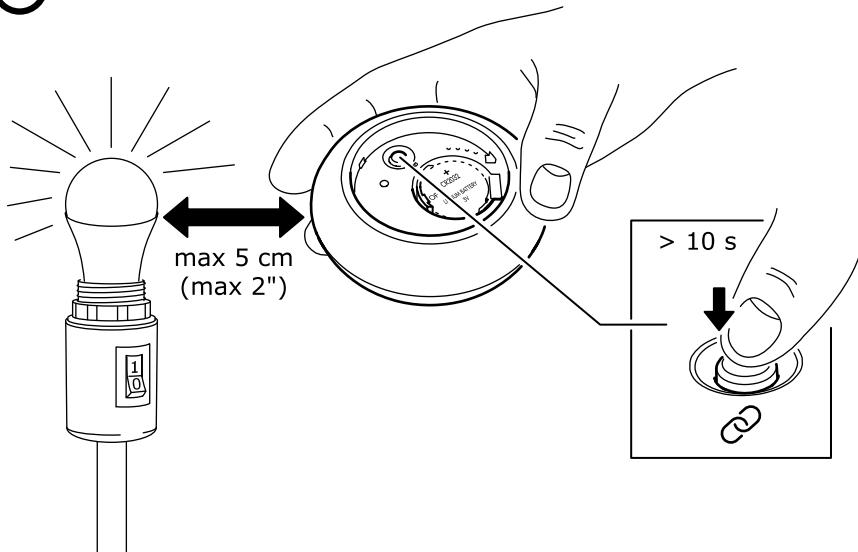



JORMLIEN



SURTE



2

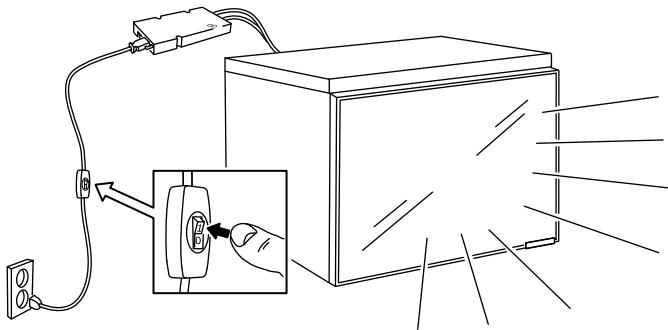

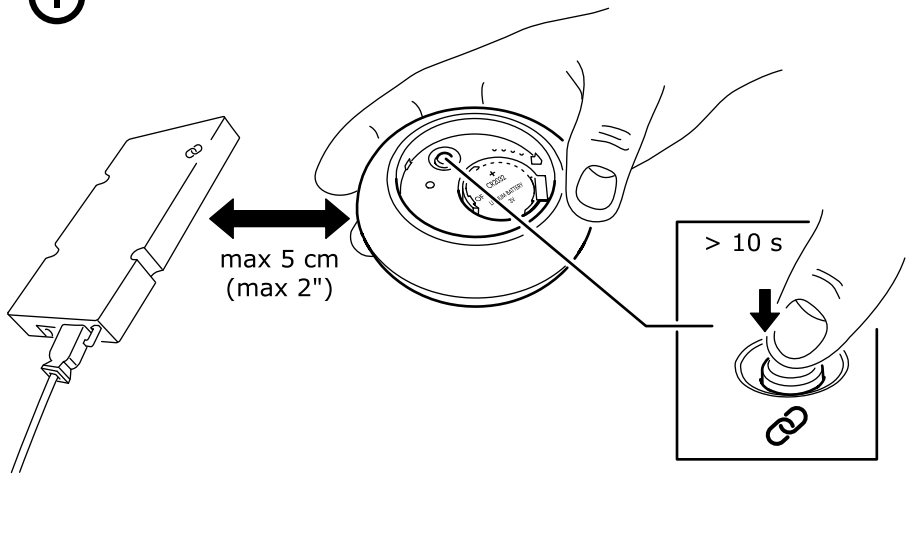

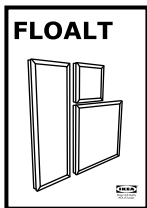

2

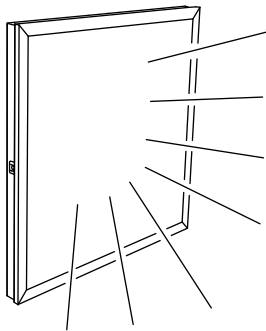
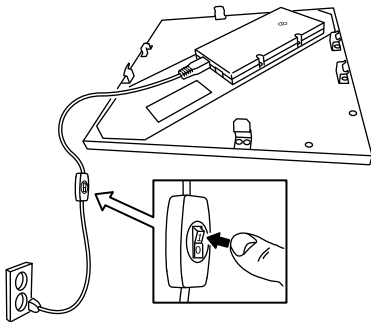

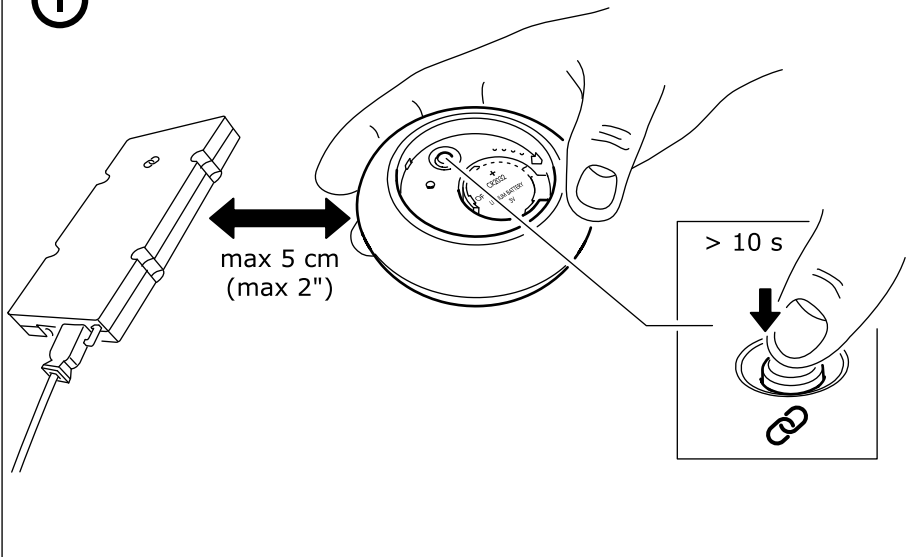

4

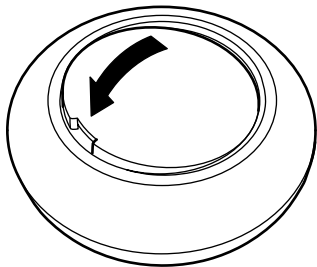

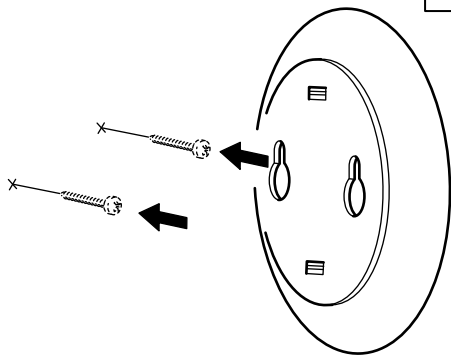
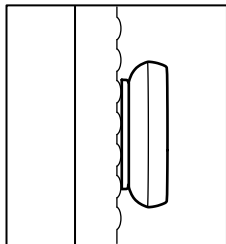
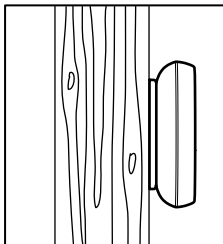

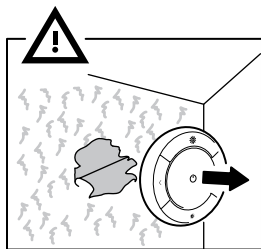
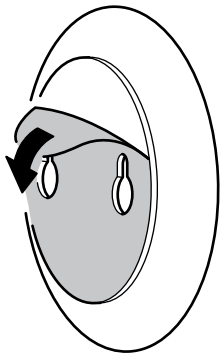
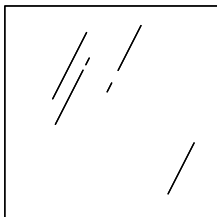
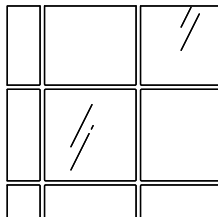
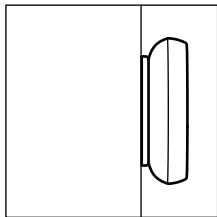

5

25 mm
(1")

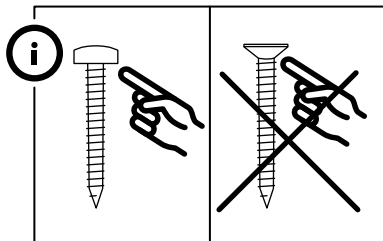
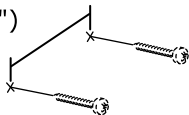

6

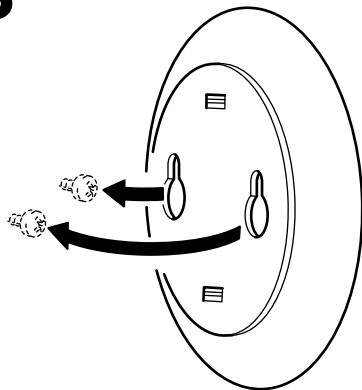

7

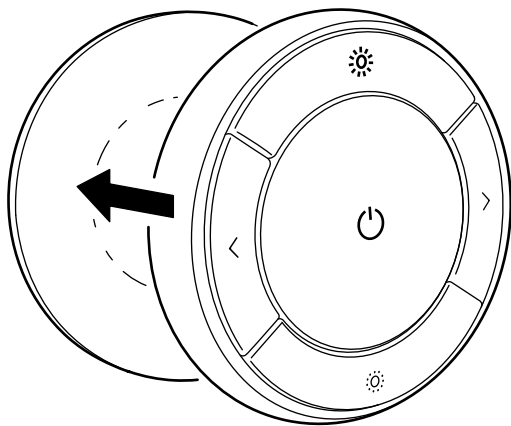

5

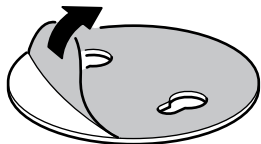
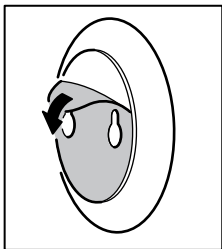

6

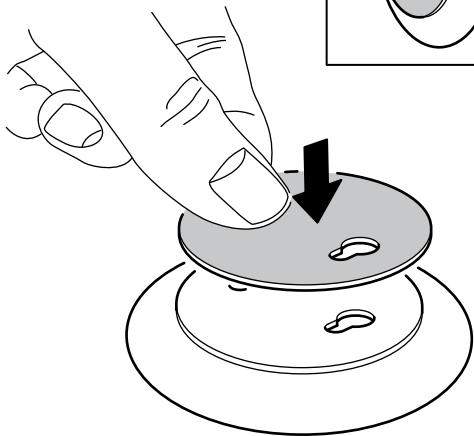

7

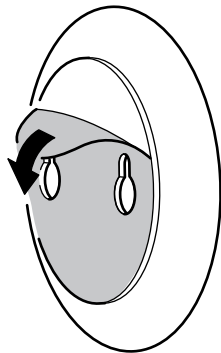

8

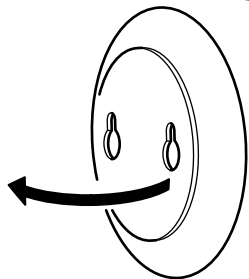

24

© Inter IKEA Systems B.V. 2017

9

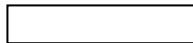
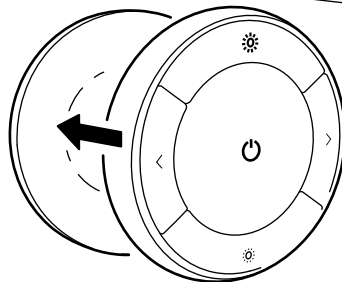

2017-05-31
AA-2034093-1